

# Foxeer Mini F722 V3 Pro

FLOWN BY BMS

- 5V/3A
- 2 PASS
- Pit
- Gyro BMI270
- CPU STM32F722RET6

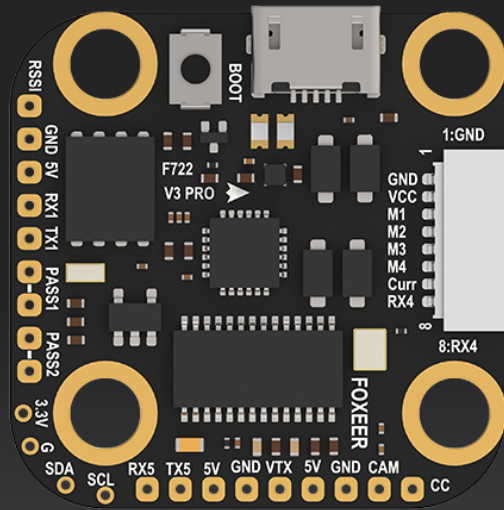

- Excellent Layout
- 2~6S Lipo
- 4 × UARTs
- Great Filtering

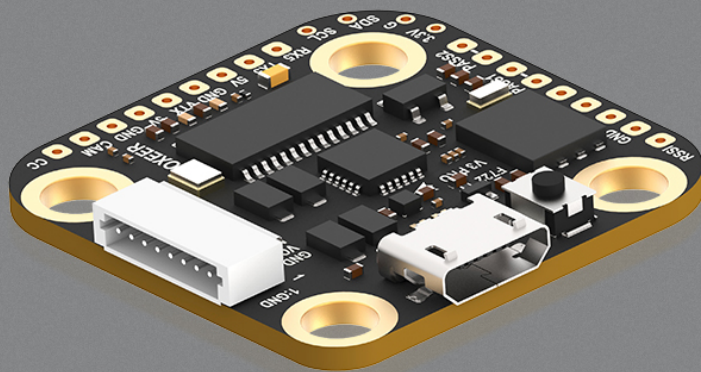

## Plug & Play with Foxeer cameras for directly remote control

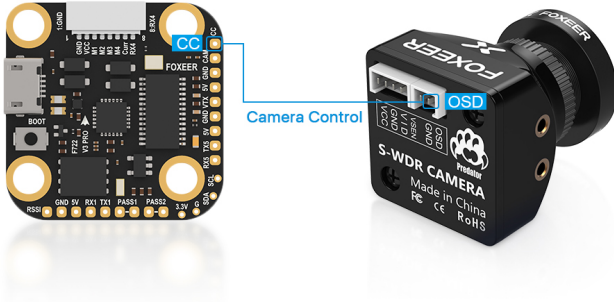

## Work with DJI HD VTX by soldering

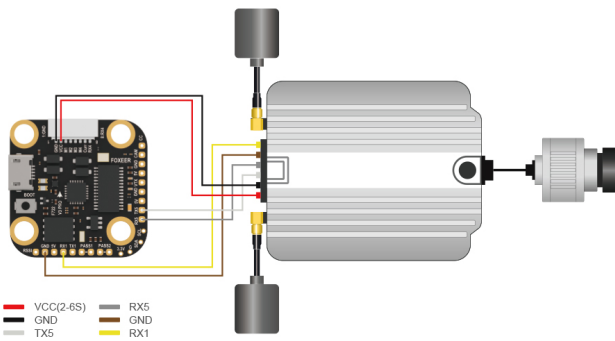

## Work with Vista VTX by soldering

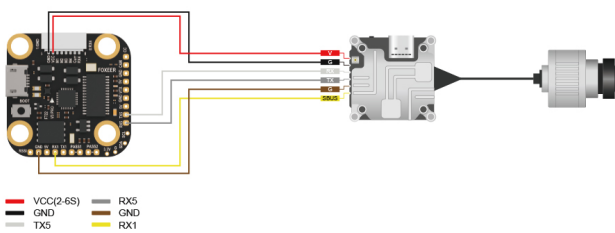

# PASS Function

Easier to wire up the quad when using Crossfire

## Normal Wiring

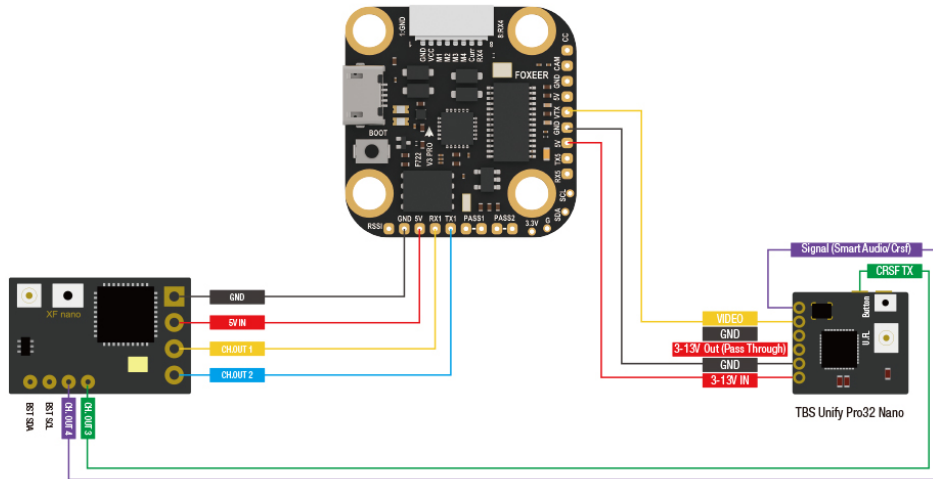

## PASS Wiring

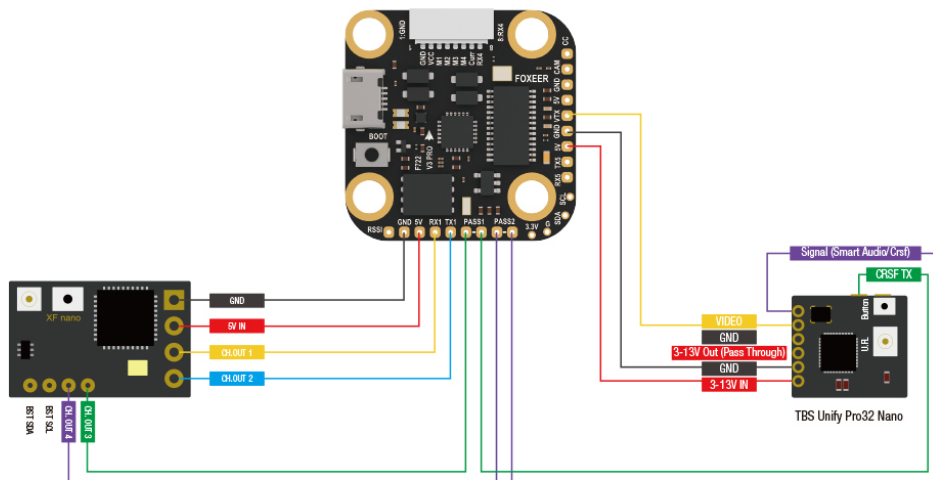

## Wiring schematic diagram

